

EKS Series



The Passionate Pursuit of Perfection

www.bole-machinery.com

BOLE Customer Service Center

BOLE MACHINERY

ADD: No.99 Weisan Road, Xiaogang, Ningbo, China

PC: 315821

TEL: +86-574-86188007

FAX: +86-574-86188008

E-mail: bole-sales@bole-machinery.com

THIS CATALOGUE ARE PROTECT BY LAW OF COPY RIGHT.
ANY USE WITHOUT THE EXPRESS PERMISSION OF THE LAW OF COPY RIGHT,
MUST GET APPROVAL OF BOLE IN ADVANCE.

THIS VERSION WAS PRINTED IN MARCH 2019,
ANY DIFFERENCE SPECIFICATION FROM OLD VERSION SHOULD BE SUBLIC TO THIS VERSION.

EKS Series

**EKS Hydraulic Servo Energy
Saving Injection Moulding Machine**

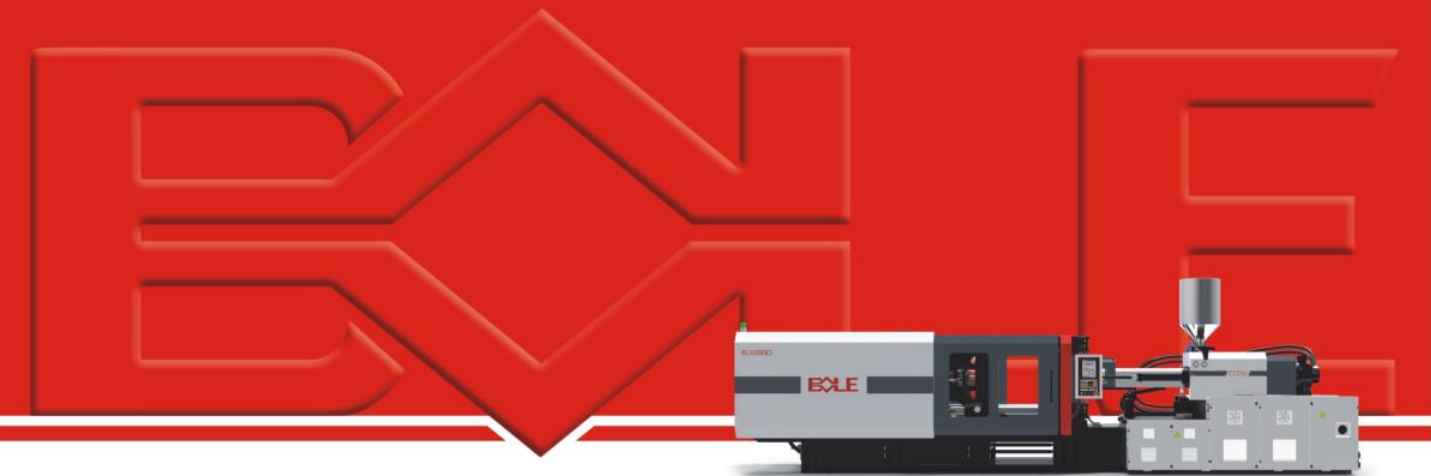

Injection Moulding Machine



More than 60 technical upgrading in terms of mechanical , electrical ,hydraulic,software and assembling process.



• Stable

Structural rigidity increased by 30% with more than 60 technical innovations, excellent performance reaches to European standards.

• Accurate

Mold open&close positioning accuracy : $\pm 0.5\text{mm}$
 Injection positioning accuracy: $\pm 0.2\text{mm}$
 Injection weight accuracy : 3%

• Economy

After sample survey, we conclude BOLE central clamping toggle design can save 2-5% material for 80% of customers' mould, comparing to traditional edge clamping toggle design.

• Intelligent

Intelligent networking management system
 March into industry 4.0 ,opening a new era of intelligent factories

High performance PLC of MMI, which getting information of the robot ,mold temperature controller, cooling water , machine accessories etc, realize data interaction, wireless networking management system. Besides, PC or cell phone terminal can always tell machine information, process parameters, operation status, failure situation and product analysis at a glance.order dispatched by computer ,which aims to working efficiency maximization, better product planning and operation control, production efficiency improvement .meanwhile ,we provide EMS data exchange terminal, making it possible to automate the whole line of the factory .

Clamping Unit

Center-clamping Structure
 Obtained the National Invention Patent of China
 (Patent No.: ZL2011 10250342.5)

EKS centre clamping structure was design and stimulate by professional software .
 overall structure rigidity increased by30%

Toggle System Comparison

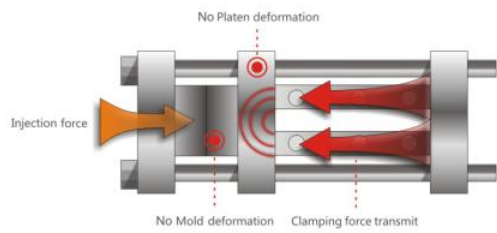

BOLE

BOLE centre clamping structure

- **100%** Clamping force efficiency
- **2-5%** Material saving
- Reduces mold wear, platen deflection
- Less possibility of flash, save flash trim work

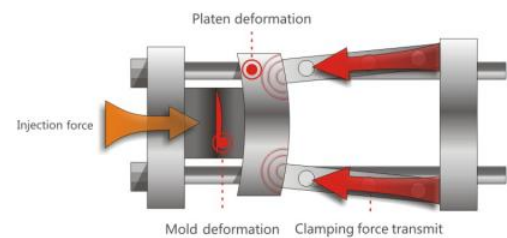

Others

Tradition Toggle system

- **80-85%** Clamping force efficiency
- Moving platen with obvious deformation, cause flashes, waste of material and labor of trim the flashes.

New designed EKS clamping structure .
 Bear averaged force ,Less platen distortion ,
 apply for more molds

New Toggle structure ,faster speed ,
 more stable, short dry cycle time

T slot plus threaded hole platen,
 to avoid damage problem.

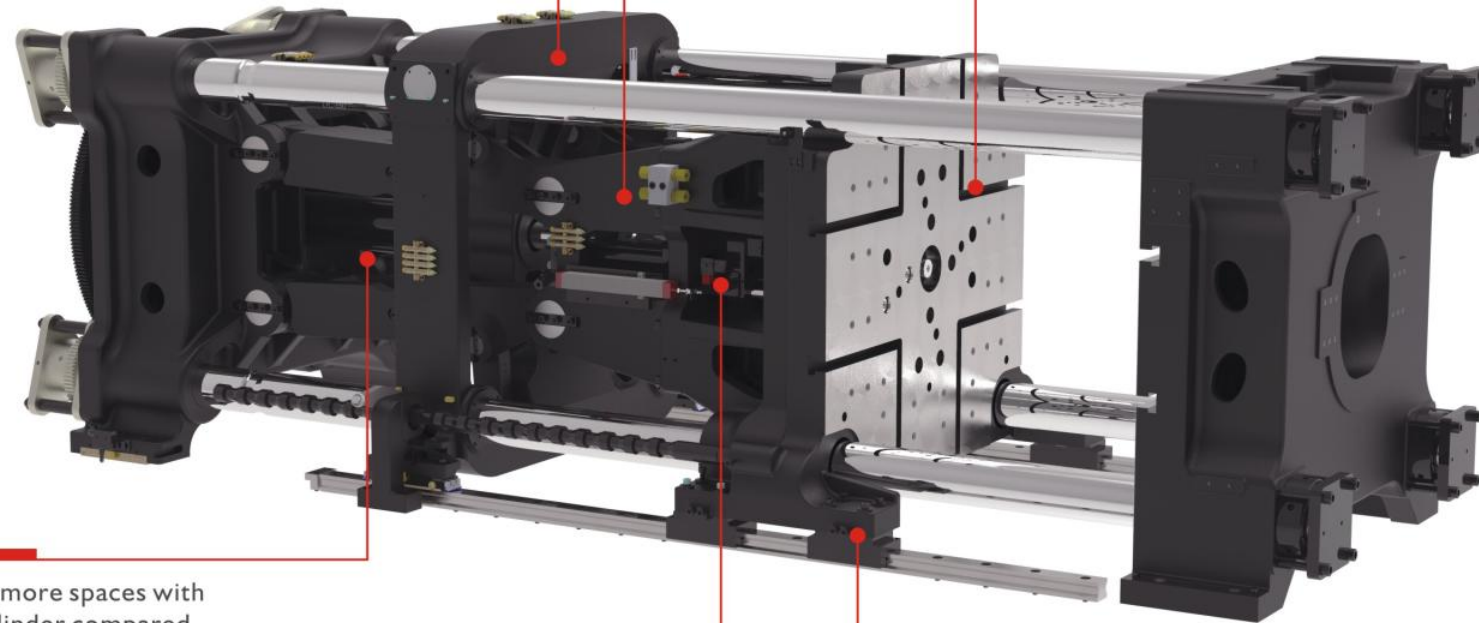

280-4000 Ton offer more spaces with
 built-in clamping cylinder compared
 with previous model

Patented pneumatic fast forced resetting
 connector, assemble & disassemble easily,
 adapted to all ejector structure.

Optimized platen structure ,
 easy to install compulsive ejector back rod.

Moving platen supporting structure:
 70-470 ton use linear guide instead of tie bar
 without lubrication to keep mold area clean.
 550ton and above use non-slip foot design to
 make the machine more stable and reliable
 when heavy mold is loaded.

Injection Unit

German Designed
Plasticizing System



- Originate form Germany design Plasticizing System, efficiency excess above 20% of domestic level
- Custom made complicated technical requirement, applied to special plasticizing system
- All series can fit with A\B\C screw, L/D ratio 23:1, to achieve the best plasticizing effect and efficiency

All series can fit with A\B\C screw, L/D ratio 23:1, to achieve the best plasticizing effect and efficiency

Originate form Germany design Plasticizing System, efficiency excess above 20% of domestic level

Upgrade module design, high rigidity injection seat, linear guide supporting structure

Enhanced cooling ring for barrel with temperature control, better charge efficiency

New injection cylinder, lower injection oil back resistance.

Strengthened charge unit, stable, long life

Compatible injection base for three different model

Hydraulic Unit

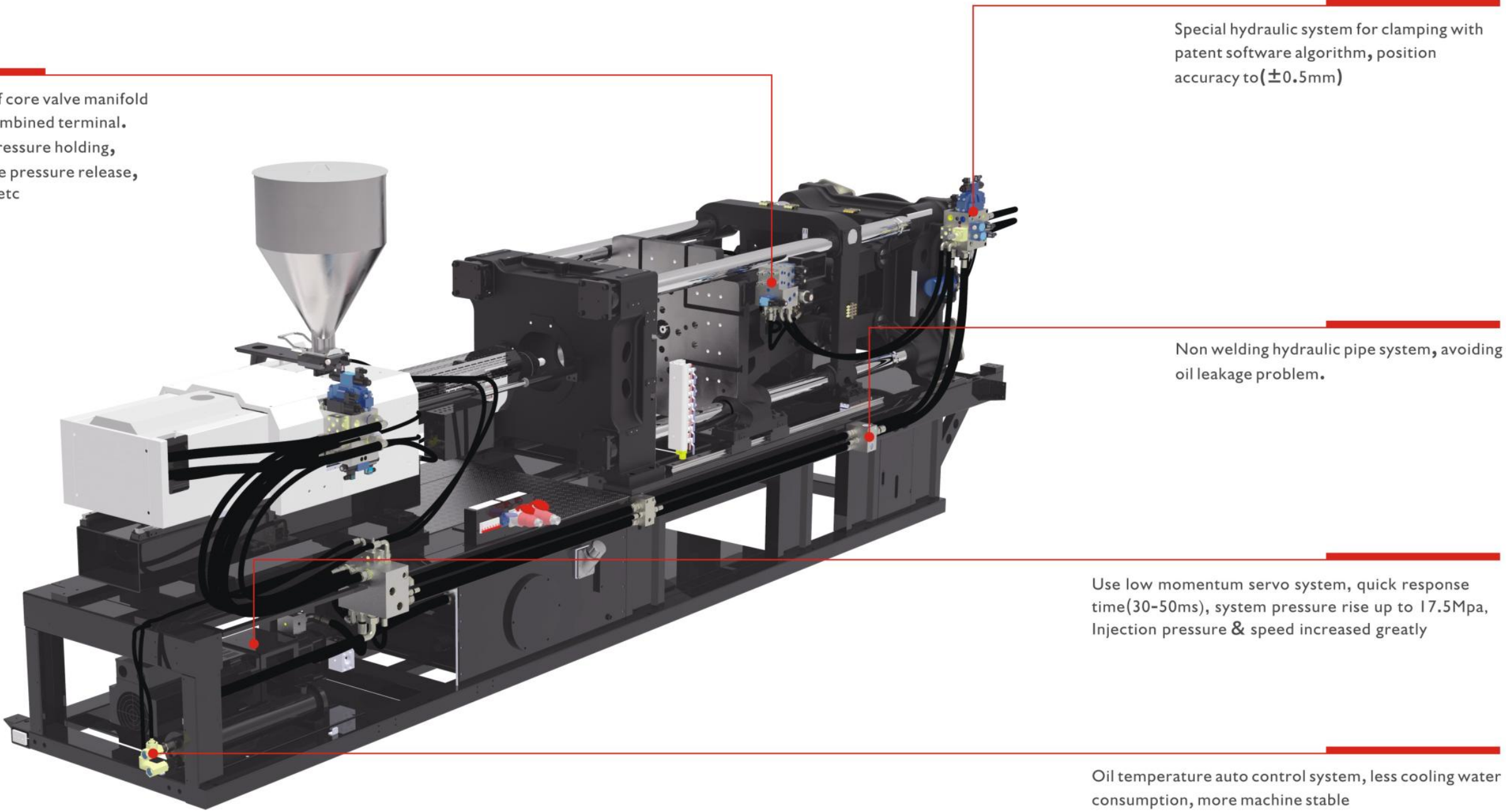

Standard 1 sets of core valve manifold for 2 joint, fast combined terminal.
Optional: core pressure holding, one press for core pressure release, hot runner valve etc

Special hydraulic system for clamping with patent software algorithm, position accuracy to $(\pm 0.5\text{mm})$

Non welding hydraulic pipe system, avoiding oil leakage problem.

Use low momentum servo system, quick response time(30-50ms), system pressure rise up to 17.5Mpa, Injection pressure & speed increased greatly

Oil temperature auto control system, less cooling water consumption, more machine stable

Intelligent Software Design

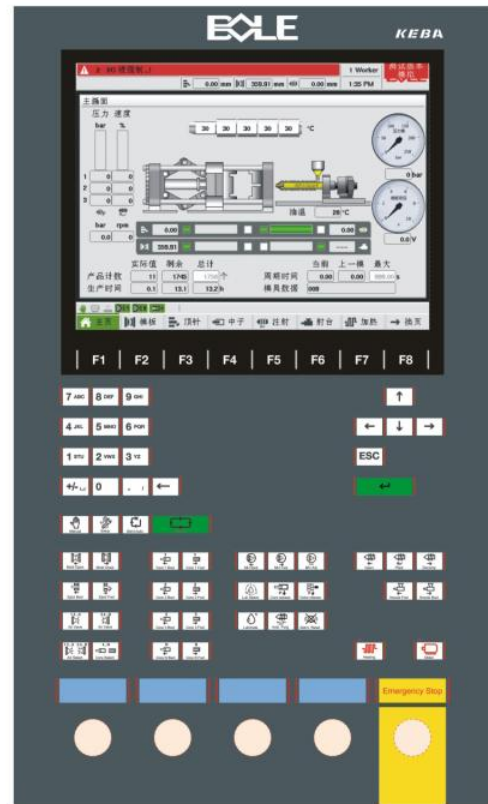

- EKS series equipped with KEBA controller as standard, BL70-850EKS equipped with KEBA-i1075 in 10", Machines above 1000T (included) all equipped with KEBA-i1080 in 12". EST Controller can be optional.
- Equipped with I/O safety advice against short circuit
- High accuracy, high intelligence and high scalability own designed control software with patent, standard with reserved interface of industrial 4.0(MES,OPC etc).
- Main electric component use brand Schneider Eaton, ABB, Fuji, which ensure long service life.
- Independent Strong and weak wire layout, high anti interference, Independent electric control box structure, convenient for installation, examination and repair.

Intelligent Networking Management System

March into industry 4.0 ,opening a new era of intelligent factories

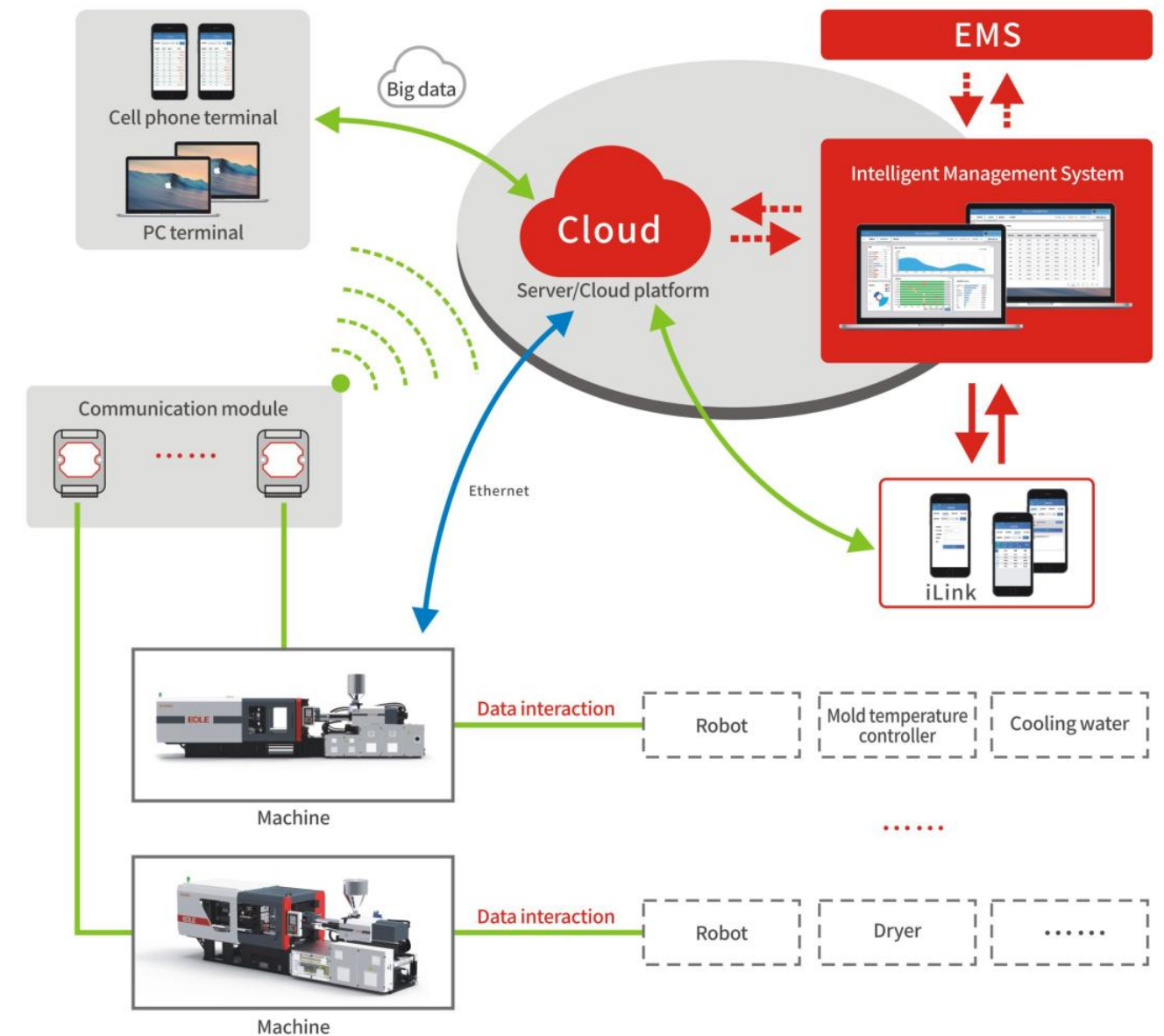

MMI high-performance PLC, which obtains robot information, from the mold temperature controller, cooling water, machine accessories, etc. It performs data processing and communicates wirelessly with the network management system. In addition, by PC or cell phone the terminal can always indicate machine information, the process of parameters, operation status, fault situation and product analysis at a glance. Controlled by the computer, it aims to maximize work efficiency, a better product, planning and operation control, production efficiency and improvement. We also offer data exchange with MES terminal, which allows to automate all the production.

Technical Data

DESCRIPTION	UNIT	BL70EKS/CI70				BL100EKS/C340				BL140EKS/C460				BL170EKS/C630				BL230EKS/C860				BL280EKS/CI450			
International specification		170				340				460				630				860				1450			
Screw specification		AA	A	B	C	AA	A	B	C	AA	A	B	C	AA	A	B	C	AA	A	B	C	AA	A	B	C
Screw diameter	mm	22	25	28	32	28	32	36	40	32	36	40	45	36	40	45	50	40	45	50	55	50	55	60	65
Screw ratio	L/D	20	23	23	23	20	23	23	23	20	23	23	23	20	23	23	23	20	23	23	23	20	23	23	23
Theoretical injection capacity	cm ³	55	71	89	117	111	145	183	226	161	203	251	318	229	283	358	442	314	397	491	594	569	689	820	962
Shot weight (PS)	g	51	65	82	107	102	133	168	208	148	187	231	292	211	260	329	406	289	366	451	546	524	634	754	885
	OZ	1.8	2.3	2.9	3.8	3.6	4.7	6.0	7.3	5.2	6.6	8.2	10.3	7.4	9.2	11.6	14.4	10.2	12.9	15.9	19.3	18.5	22.4	26.6	31.3
Injection rate into Air	cm ³ /s	61	78	98	128	78	102	130	160	105	133	164	208	114	141	178	220	139	176	217	263	192	232	276	324
Injection pressure	MPa	318	246	196	150	313	239	189	153	291	230	186	147	275	223	176	143	277	219	177	147	256	211	178	151
Injection stroke	mm	145				180				200				225				250				290			
Max. injection speed	mm/s	160				127				131				112				111				98			
Screw speed	r/min	300				280				250				215				221				210			
Clamping force	kN	700				1000				1400				1700				2300				2800			
Opening stroke	mm	320				360				420				480				530				580			
Space between tie bar	mmXmm	360X330				410X360				460X410				510X460				560X510				660X610			
Min. mould height	mm	140				160				180				200				220				240			
Max. mould height	mm	370				420				470				530				580				680			
Max. distance Platen	mm	690				780				890				1010				1110				1260			
Ejector stroke	mm	70				100				130				150				150				190			
Ejector force forward	kN	31				34				49				49				67				68			
Ejector force back	kN	20				22				37				37				39				44			
Number of ejector bar	PC	5				5				5				5				9				13			
Sys. Pressure	MPa	17.5				17.5				17.5				17.5				17.5				17.5			
Pump Motor	kW	8.9				13.4				16.4				16.4				20.5				26.7			
Heater power	kW	4.6	5.4	6.1	6.9	5.8	6.8	7.9	9	7.8	8.8	10	11.3	11.2	12	13.2	14.4	11.4	13	14.6	16.2	18.5	18.5	21	23
Number of temp. control zones		3+1				3+1				3+1				3+1				4+1				4+1			
Hoper capacity	kg	25				25				25				50				50				50			
Oil tank capacity	L	120				150				180				230				280				350			
Machine dimensions (L×W×H)	mXmXm	3.8X1.2X1.7				4.2X1.22X1.85				4.8X1.35X1.85				5.3X1.53X2.15				5.8X1.55X2.15				6.4X1.58X2.2			
Machine weight	ton	3.1				3.7				4.5				6.5				7				9			

Platen Side size

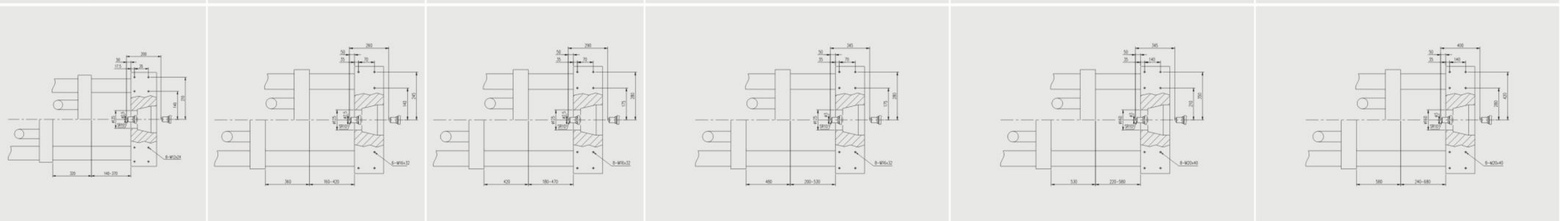

Technical Data

DESCRIPTION	UNIT	BL350EKS/C2050				BL470EKS/C3000				BL550EKS/C3700				BL650EKS/C4800				BL750EKS/C5900				BL850EKS/C7900			
International specification		2050				3000				3700				4800				5900				7900			
Screw specification		A	B	C	D	A	B	C	D	A	B	C	D	A	B	C	D	A	B	C	D	A	B	C	D
Screw diameter	mm	60	65	75	80	70	75	85	90	75	80	90	95	80	85	90	100	80	90	100	110	90	100	110	120
Screw ratio	L/D	23	23	23	21.3	23	23	23	21.5	23	23	23	21.7	23	23	23	20.7	23	23	23	21	23	23	23	21
Theoretical injection capacity	cm ³	918	1078	1435	1633	1423	1634	2099	2353	1832	2085	2639	2940	2286	2581	2893	3572	2512	3179	3925	4749	3465	4278	5177	6161
Shot weight (PS)	g	845	992	1320	1502	1309	1503	1931	2164	1686	1918	2428	2705	2103	2374	2662	3286	2311	2925	3611	4369	3188	3936	4763	5668
	oz	29.9	35.0	46.7	53.1	46.2	53.1	68.2	76.5	59.6	67.8	85.8	95.6	74.3	83.9	94.1	116.1	81.7	103.4	127.6	154.4	112.7	139.1	168.3	200.3
Injection rate into Air	cm ³ /s	271	271	423	481	361	361	532	597	451	513	649	723	510	576	646	798	547	547	854	1034	666	822	995	1184
Injection pressure	MPa	226	193	145	127	212	185	144	128	204	179	142	127	210	186	166	134	230	181	147	121	230	186	154	129
Injection stroke	mm	325				370				415				455				500				545			
Max. injection speed	mm/s	96				94				102				102				106				105			
Screw speed	r/min	175				164				158				153				139				122			
Clamping force	kN	3500				4700				5500				6500				7500				8500			
Opening stroke	mm	660				750				850				950				1050				1100			
Space between tie bar	mmXmm	710X660				810X760				860X800				960X860				1060X960				1120X1020			
Min. mould height	mm	270				300				350				400				450				450			
Max. mould height	mm	720				820				880				1000				1100				1150			
Max. distance Platen	mm	1380				1570				1730				1950				2150				2250			
Ejector stroke	mm	190				220				220				240				270				300			
Ejector force forward	kN	68				116				116				152				198				198			
Ejector force back	kN	44				72				72				107				129				129			
Number of ejector bar	PC	13				17				17				21				21				21			
Sys. Pressure	MPa	17.5				17.5				17.5				17.5				17.5				17.5			
Pump Motor	kW	40.9				50.7				16.4+40.9				16.4+50.7				26.7+50.7				50.7+50.7			
Heater power	kW	21.8	24	26.2	26.2	27	29.2	31.4	31.4	32	35.5	37.5	37.5	36	38.3	40.6	40.6	43	48.5	54	59.5	50	54.2	58.4	58.4
Number of temp. control zones		4+1				4+1				5+1				5+1				5+1				6+1			
Hoper capacity	kg	50				50				100				100				100				100			
Oil tank capacity	L	420				500				750				850				1000				1200			
Machine dimensions (L×W×H)	mXmXm	6.9X1.75X2.25				7.8X2X2.3				8.5X2.2X2.6				9X2.3X2.7				9.8X2.7X2.7				10.2X2.7X2.7			
Machine weight	ton	12.5				17				20				25				31				40			

Platen Side size

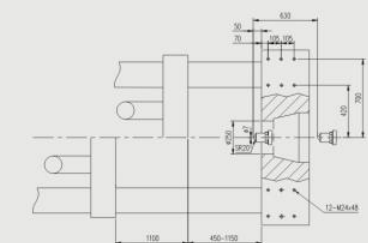
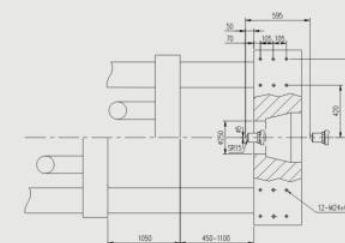
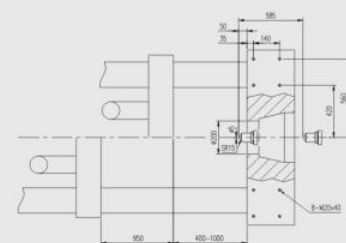
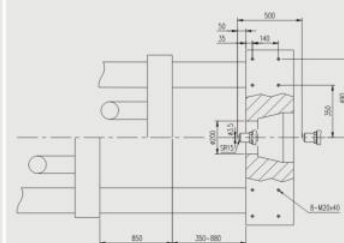
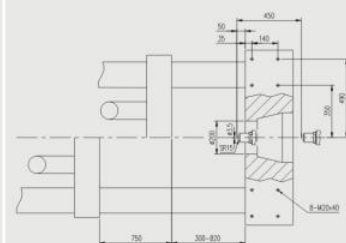
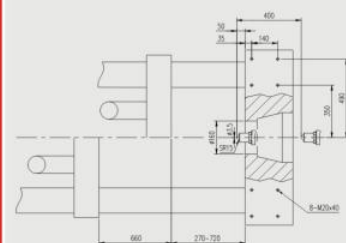

Technical Data

DESCRIPTION	UNIT	BLI000EKS/CI0000				BLI200EKS/CI0000				BLI400EKS/CI3500				BLI600EKS/CI9300				BLI850EKS/CI9300				BL2200EKS/C25000			
International specification		I0000				I0000				I3500				I9300				I9300				25000			
Screw specification		A	B	C	D	A	B	C	D	A	B	C	D	A	B	C	D	A	B	C	D	A	B	C	D
Screw diameter	mm	100	110	120	130	100	110	120	130	110	120	130	140	120	135	145	155	120	135	145	155	140	150	160	170
Screw ratio	L/D	23	23	23	21.2	23	23	23	21.2	23	23	23	21.3	23	23	23	21.5	23	23	23	21.5	23	23	23	21.6
Theoretical injection capacity	cm ³	4671	5652	6726	7894	4671	5652	6726	7894	6079	7235	8491	9847	8195	10372	11966	13673	8195	10372	11966	13673	12078	13865	15775	17809
Shot weight (PS)	g	4297	5199	6188	7262	4297	5199	6188	7262	5593	6656	7811	9059	7540	9543	11009	12579	7540	9543	11009	12579	11112	12756	14513	16384
	OZ	151.8	183.7	218.7	256.6	151.8	183.7	218.7	256.6	197.6	235.2	276.0	320.1	266.4	337.2	389.0	444.5	266.4	337.2	389.0	444.5	392.6	450.7	512.8	578.9
Injection rate into Air	cm ³ /s	820	820	1180	1385	820	820	1180	1385	969	969	1353	1569	1105	1105	1614	1844	1105	1105	1614	1844	1361	1361	1778	2007
Injection pressure	MPa	215	178	149	127	215	178	149	127	221	186	158	137	236	186	161	141	236	186	161	141	214	186	164	145
Injection stroke	mm	595				595				640				725				725				785			
Max. injection speed	mm/s	104				104				102				98				98				88			
Screw speed	r/min	114				114				108				101				101				80			
Clamping force	kN	10000				12000				14000				16000				18500				22000			
Opening stroke	mm	1150				1320				1450				1550				1680				1850			
Space between tie bar	mmXmm	1160X1060				1260X1120				1420X1220				1520X1320				1620X1420				1720X1520			
Min. mould height	mm	500				550				650				700				750				750			
Max. mould height	mm	1200				1300				1450				1550				1650				1750			
Max. distance Platen	mm	2350				2620				2900				3100				3330				3600			
Ejector stroke	mm	300				350				350				400				400				450			
Ejector force forward	kN	222				222				332				332				429				429			
Ejector force back	kN	139				139				249				249				330				330			
Number of ejector bar	PC	21				21				29				29				29				33			
Sys. Pressure	MPa	17.5				17.5				17.5				17.5				17.5				17.5			
Pump Motor	kW	20.5+40.9+50.7				20.5+40.9+50.7				40.9+50.7+50.7				40.9+40.9+40.9+50.7				40.9+40.9+40.9+50.7				40.9+50.7+50.7+50.7			
Heater power	kW	56.2	60.4	62.4	62.4	56.2	60.4	62.4	62.4	74.6	78.1	81.6	81.6	70.7	76.5	80.7	80.7	89.9	95.7	99.8	99.8	112.1	116.4	120.7	120.7
Number of temp. control zones		6+1				6+1				7+1				7+1				7+1				8+1			
Hoper capacity	kg	200				200				200				200				200				400			
Oil tank capacity	L	1400				1400				1650				2250				2250				2500			
Machine dimensions (L×W×H)	mXmXm	11.3X3.1X3.9				11.5X3.1X3.9				12.5X3.3X4.15				13.8X3.56X4.3				14.5X3.6X4.3				15.5X3.75X4.3			
Machine weight	ton	45				52				67				94				106				132			

Platen Side size

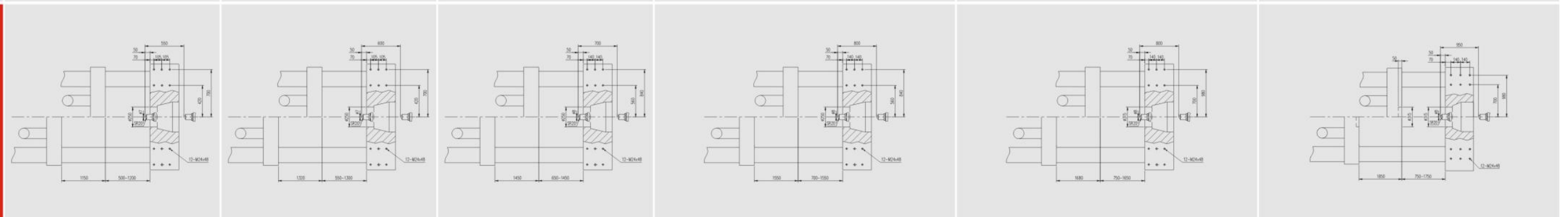

Technical Data

DESCRIPTION	UNIT	BL2500EKS/C36000				BL2800EKS/C49000				BL3300EKS/C80000				BL4000EKS/C120000			
International specification		36000				49000				80000				120000			
Screw specification		A	B	C	D	A	B	C	D	A	B	C	D	A	B	C	D
Screw diameter	mm	160	170	185	195	170	190	200	220	210	220	240	260	220	240	260	270
Screw ratio	L/D	23	23	23	21.7	23	23	23	21.4	23	23	23	22	23	23	23	22.1
Theoretical injection capacity	cm ³	18589	20985	24852	27611	23707	29614	32813	39704	41888	45973	54711	64210	57751	68728	80660	86984
Shot weight (PS)	g	17102	19306	22863	25402	21811	27245	30188	36527	38537	42295	50334	59073	53131	63230	74207	80026
	oz	604.3	682.2	807.9	897.6	770.7	962.7	1066.7	1290.7	1361.7	1494.5	1778.6	2087.4	1877.4	2234.3	2622.2	2827.8
Injection rate into Air	cm ³ /s	1546	1546	2067	2296	1700	1700	2354	2848	2251	2251	2940	3450	2213	2213	3090	3333
Injection pressure	MPa	198	175	148	133	209	167	151	125	190	174	146	124	208	174	149	138
Injection stroke	mm	925				1045				1210				1520			
Max. injection speed	mm/s	77				75				65				58			
Screw speed	r/min	68				69				60				63			
Clamping force	kN	25000				28000				33000				40000			
Opening stroke	mm	2000				2100				2200				2350			
Space between tie bar	mmXmm	1820X1620				1920X1720				2110X1910				2420X2220			
Min. mould height	mm	800				900				1000				1100			
Max. mould height	mm	1850				1950				2000				2100			
Max. distance Platen	mm	3850				4050				4200				4450			
Ejector stroke	mm	500				500				550				600			
Ejector force forward	kN	429				429				577				577			
Ejector force back	kN	330				330				443				443			
Number of ejector bar	PC	33				33				25				25			
Sys. Pressure	MPa	17.5				17.5				17.5				17.5			
Pump Motor	kW	50.7 + 50.7 + 50.7 + 50.7				50.7 + 50.7 + 50.7 + 50.7 + 26.7				50.7 + 50.7 + 50.7 + 50.7 + 40.9 + 40.9				50.7 + 50.7 + 50.7 + 50.7 + 50.7 + 50.7			
Heater power	kW	175.8	180.7	188.7	188.7	222.7	233.7	239.5	239.5	222.7	229.1	242.9	242.9	246	259.8	274.8	274.8
Number of temp. control zones		8+1				8+1				8+1				8+1			
Hoper capacity	kg	400				400				400				400			
Oil tank capacity	L	2750				3000				3500				4000			
Machine dimensions (L×W×H)	mXmXm	17.5X3.95X4.5				18.6X3.95X5.1				20.5X4.45X5.6				22.5X4.65X6			
Machine weight	ton	160				190				265				320			

Platen Side size

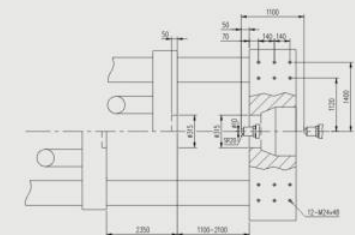
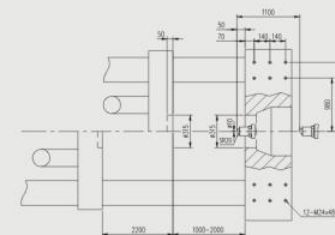
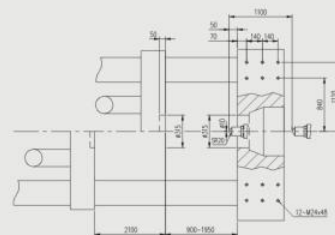
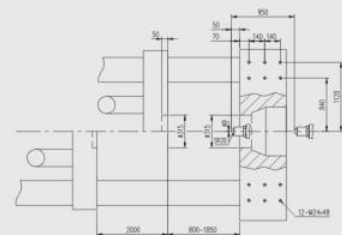

Platen Size

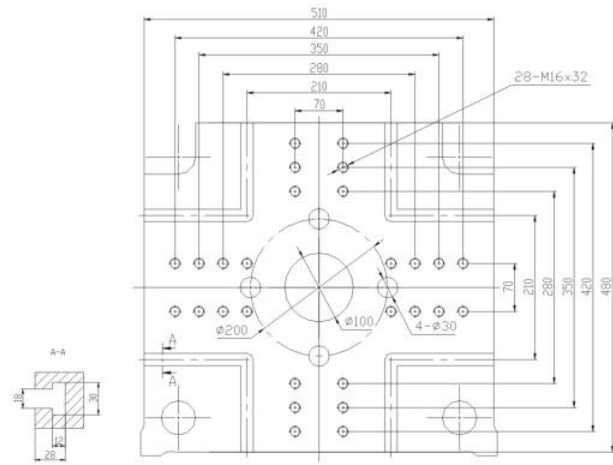

BL70EKS

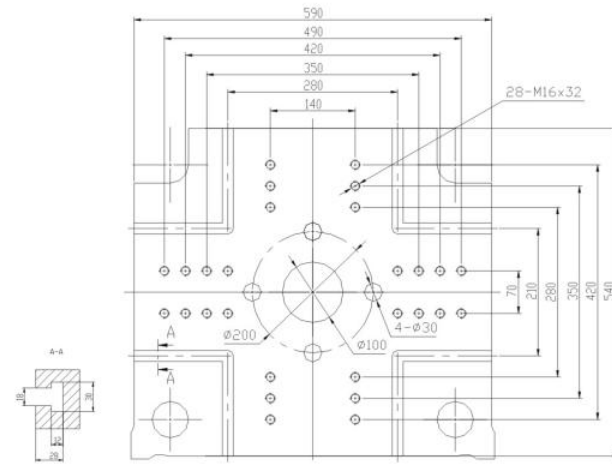

BL100EKS

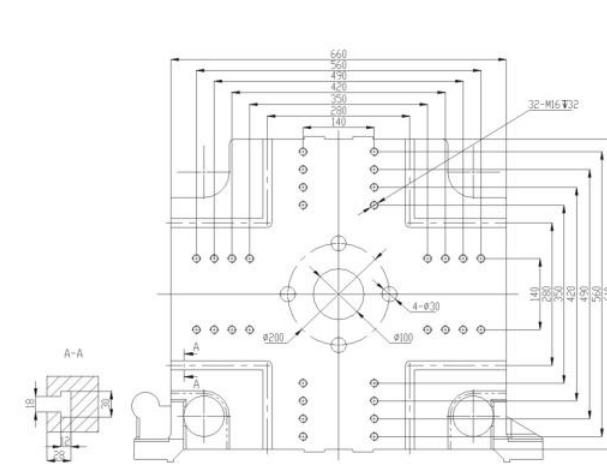

BL140EKS

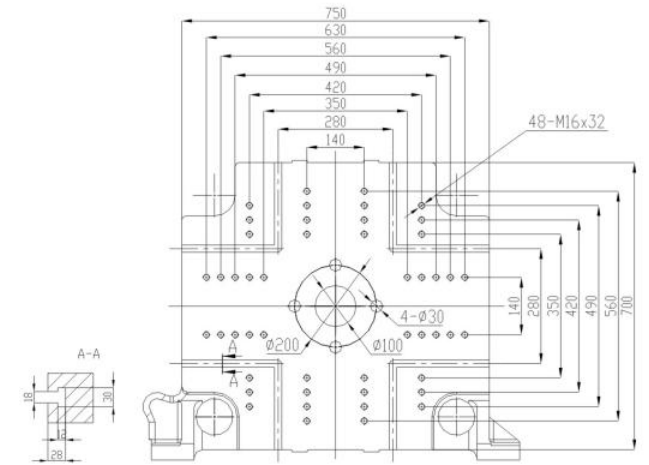

BL170EKS

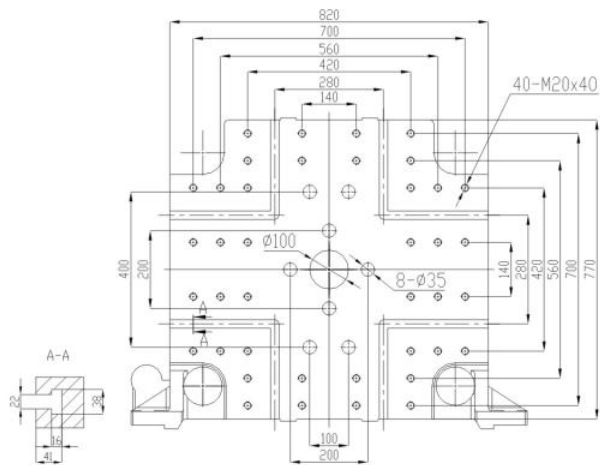

BL230EKS

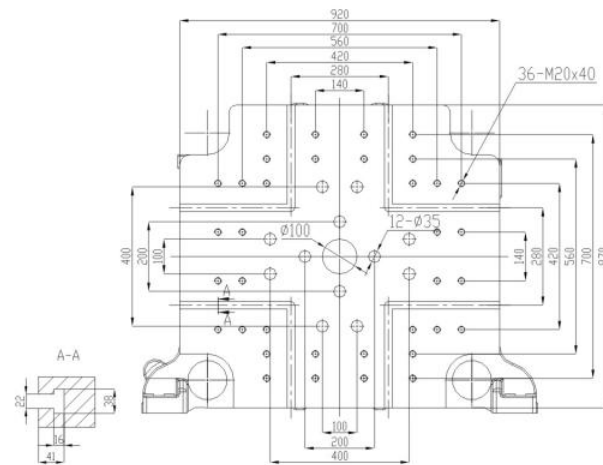

BL280EKS

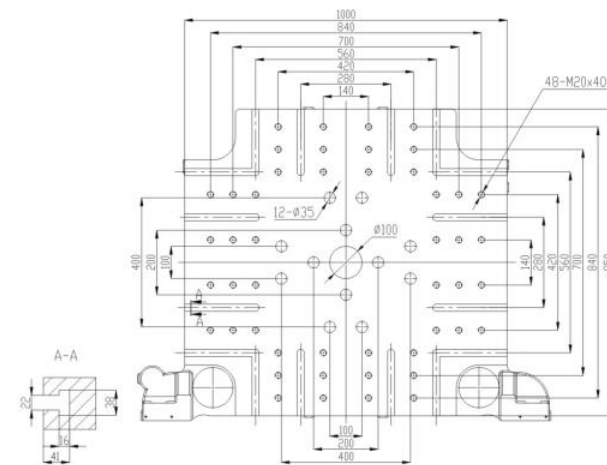

BL350EKS

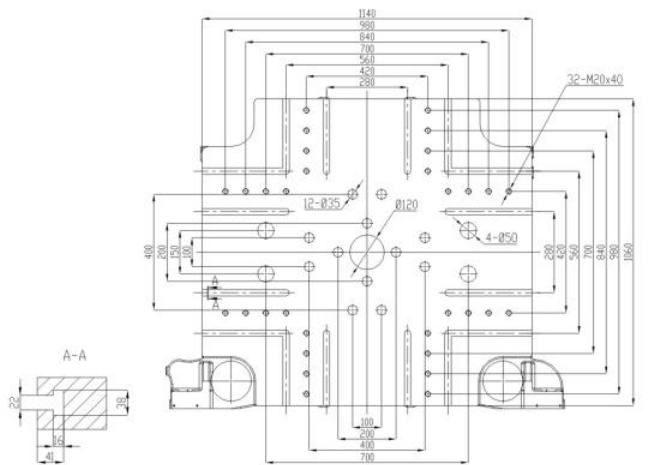

BL470EKS

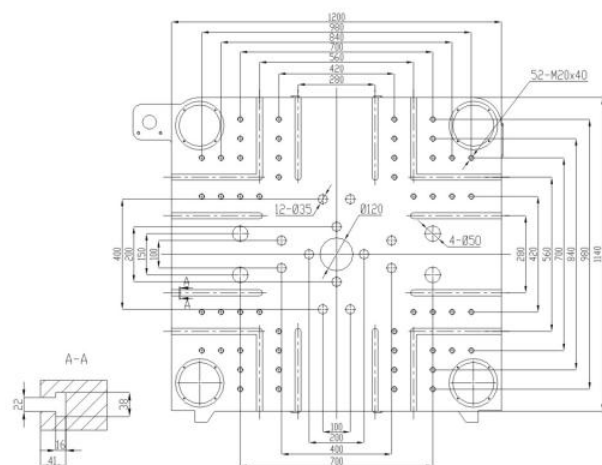

BL550EKS

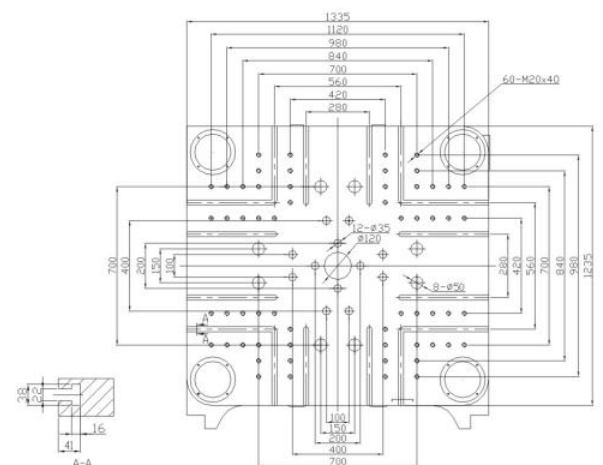

BL650EKS

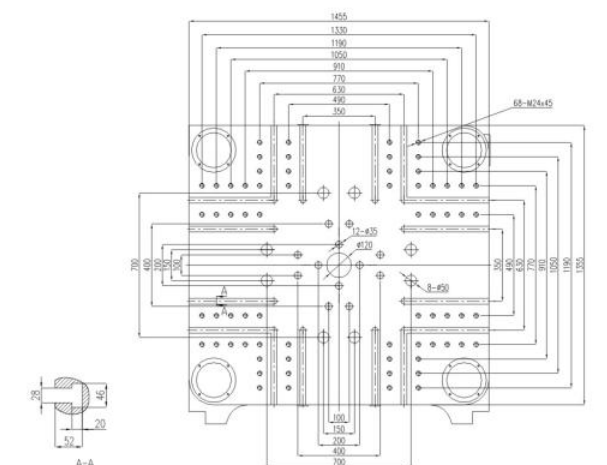

BL750EKS

Platen Size

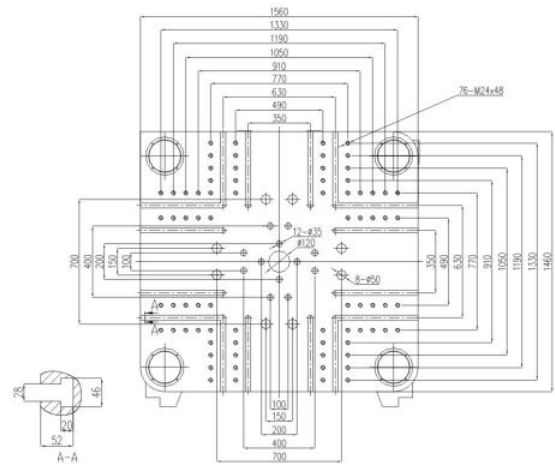

BL850EKS

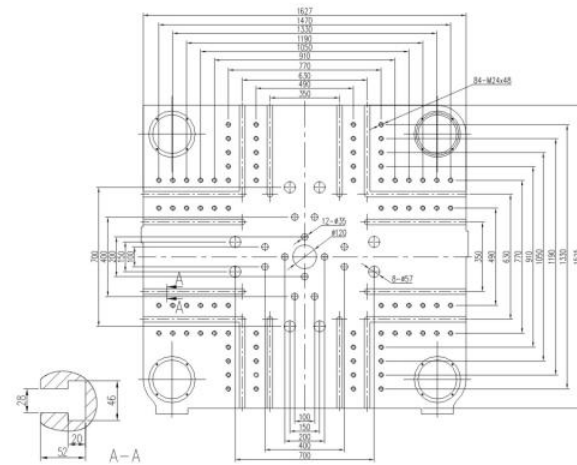

BL1000EKS

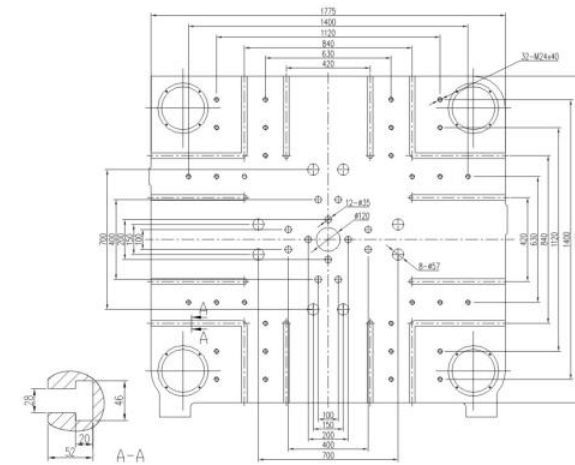

BL1200EKS

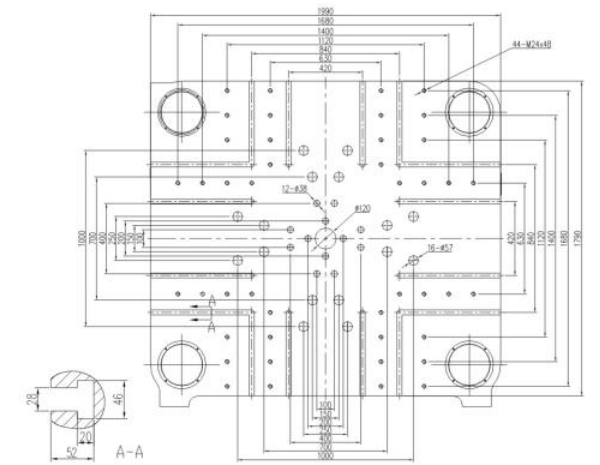

BL1400EKS

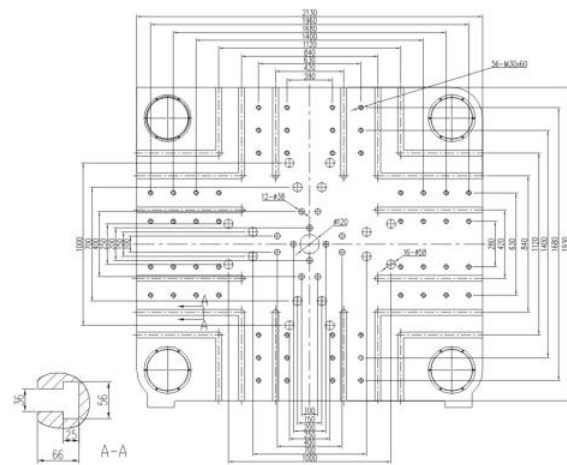

BL1600EKS

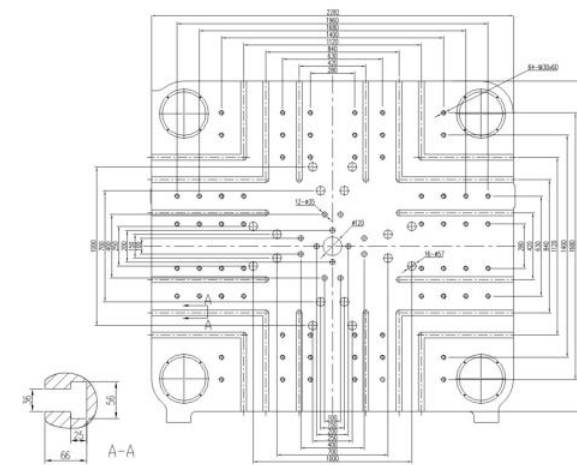

BL1850EKS

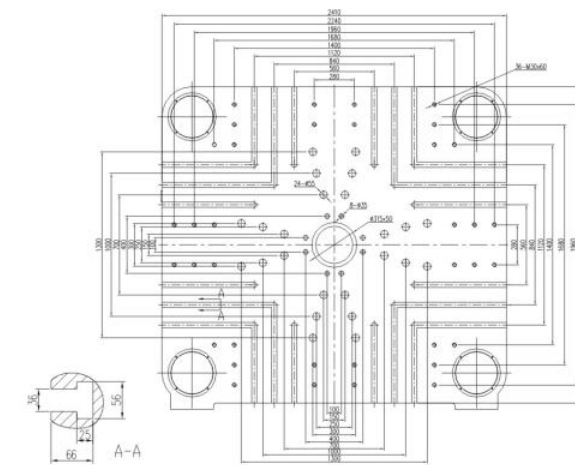

BL2200EKS

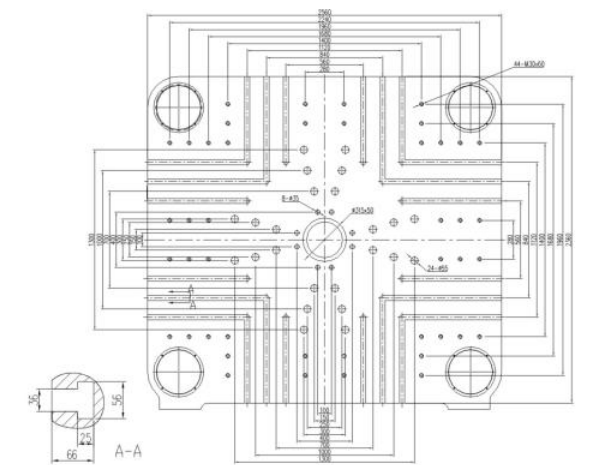

BL2500EKS

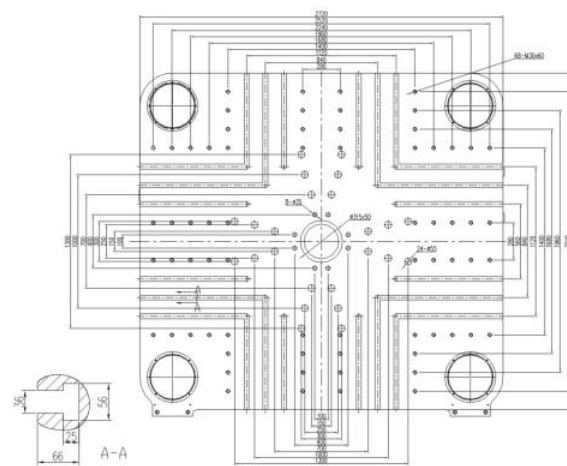

BL2800EKS

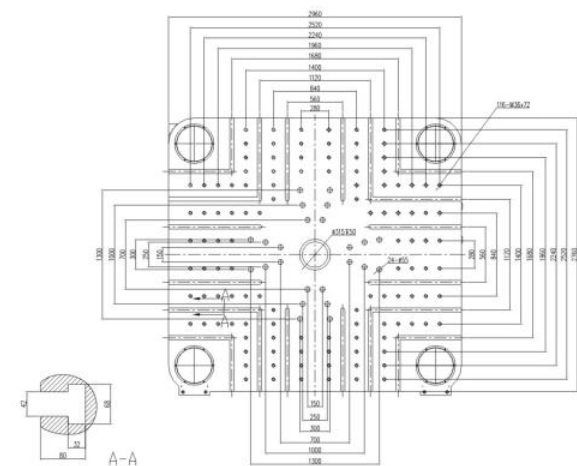

BL3300EKS

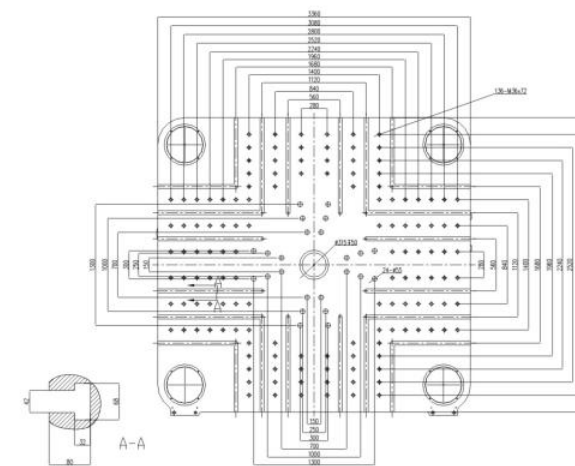

BL4000EKS

● Standard ◎ Optional

Clamping Unit	70-470EKS		550-1850EKS		2200-4000EKS	
	Standard	Optional	Standard	Optional	Standard	Optional
Upgraded version of the patented outside five-point mold clamping structure	●		●		●	
Manual lubrication of mold adjustment nut	●		●		●	
Platen /cross head/toggle use qt500-7 high rigid ductile iron	●		●		●	
T slot platen	●		●		●	
The sliding foot of moving plate is supported by linear guideway	●					
Anti-down support in slide shoes of movable platen, high hardness steel strip, reduce the deformation of tie-bar			●		●	
EU2 mold mounting dimension	●		●		●	
Hydraulic and Electric, dual security protection	●		●		●	
hydraulic motor drive gear automatic mould high adjust mould	●		●		●	
Automatic adjustment of clamping force on demand	●		●		●	
EU18 robot postion	●		●		●	
Low pressure mould protect with high precision/low pressure mould protect with high precision	●		●		●	
Equipped with safety screen in the clamping unit.			●		●	
Auto-door control and safety switch in its bottom and confirmed button in mold closing.			●		●	
The operation of the open/close mold ,ejection is controlled by a high precision electronic ruler.	●		●		●	
High precision open-close mold positioning control system, positioning repetition accuracy up to ±0.5 mm (patent design)	●		●		●	
Optional:multiple ejector model, saperated setting pressure, speed.	●		●		●	
Equipped with synchronous ejector and core pulling system.			●		●	
Five process in mold opening and mold closing, adjustable pressure	●		●		●	
Self-detector for volumetric central oil lubrication, equipped with terminal pressure detection	●		●		●	
Fully enclosed safety sheet metal, movable safty door	●		●		●	
Open type security door (1000-4000eks)			●		●	
Safe top cover plate for clamping area (70-280eks)	●					
1 set water manifold	●					
2 sets water manifold			●		●	
Buffer strip for security door	●		●		●	
Magnetic platen		◎		◎		◎
Hydraulic clamper		◎		◎		◎
Moveable tiebar		◎		◎		◎
Mould heat shiled plate		◎		◎		◎
Bigger mould height		◎		◎		◎
Electric/dydraulic spin demolding system		◎		◎		◎
Mold lifting rod		◎				
Wider machine cover&door		◎		◎		◎
Heightened frame(70-850eks)		◎				
Central ejector rod reinforce reseting function		◎		◎		◎
Bigger eject force		◎		◎		◎
Bigger eject stroke		◎		◎		◎
Compulsive ejector back device		◎		◎		◎
Machanical safety protection		◎		◎		
Sepecial water manifold(flow meter)		◎		◎		◎
2 air blow		◎		◎		◎
Automatic lubrication of mold adjustment nut		◎		◎		◎
Screw hole platen		◎		◎		◎

● Standard ◎ Optional

Injection Unit	70-470EKS		550-1850EKS		2200-4000EKS	
	Standard	Optional	Standard	Optional	Standard	Optional
A new type of double cylinder balanced injection system with ultra low oil return resistance	●		●		●	
Linear guide rail support structure	●		●		●	
Low speed but in large torque hydraulic motor	●		●		●	
Design of high quality nitride steel high efficiency plasticizing screw barrel in germany	●		●		●	
Ceramic heating band	●		●		●	
Multi-section pid temperature control for nozzle and barrel	●		●		●	
Fully enclosed heat shield	●		●		●	
Twin injection cyclinder design	●		●		●	
Injection stroke control with precise transducer	●		●		●	
The strimming device of the nozzle	●		●		●	
Time-setting heating function,to start	●		●		●	
Screw anti-fluid device (pull-out/retract/suck back)	●		●		●	
High rigid beam supporting structure	●		●		●	
Six stages of injection,five stages of holding pressure,five stages of charging,pressure/speed can be adjusted	●		●		●	
Screw rotation speed detection	●		●		●	
Auto purge function for cleaning the barrel function	●		●		●	
Proportional back pressure	●		●		●	
Central lubrication in injection unit	●		●		●	
Bearing type mobile hopper seat with ordinary hopper 1000-4000EKS loading platform)	●		●			
Feeding plate, without hopper (1000-4000EKS)			●		●	
Barrel supporting structure			●		●	
Anti-slip board for injection base	●		●		●	
Extented nozzle,extent to 50mm.	●			◎		◎
Extented nozzle,extent to 100mm.		◎	●		●	
Spring or hydraulic,penumatic and self-locking nozzle		◎		◎		◎
Hopper temperature control		◎		◎		◎
Enlarging the carriging structure		◎		◎		◎
Reducing shot out the structure		◎		◎		◎
Special special screw barrel (electroplating, alloy, all hard pcmma, pbt,pa, etc.)		◎		◎		◎
Central self-lubrication in injection unit		◎		◎		◎
Infrared heating band		◎		◎		◎
Barrel fan cooling system		◎		◎		◎
Electrical charge		◎		◎		◎
Hydraulic synchronous melting system		◎		◎		◎
Penumatic assistant injection signal interface		◎		◎		◎
Signal interface of color machine		◎		◎		◎
Micro - foaming molding		◎		◎		◎

● Standard ◎ Optional

Control Unit	70-470EKS		550-1850EKS		2200-4000EKS	
	Standard	Optional	Standard	Optional	Standard	Optional
KEBA Computer 12 inch color screen (BL1000EKS-BL4000EKS)			●		●	
KEBA Computer 10 inch color screen (BL70EKS-BL850EKS)	●		●			
Transducer, weak current switch, solenoid valve line, control line with waterproof bellows.	●		●		●	
Equipped set value reference & online operation help function	●		●		●	
Simple robot interface	●		●		●	
Multiple operating language	●		●		●	
Safety realy module monitoring	●		●		●	
Tricolor alarm light	●		●		●	
Real-time clamping force monitoring	●		●		●	
The driver adopts ac contactor protection device	●		●		●	
Parameter data protection lock	●		●		●	
Pid automatic temperature control,realizes the cylinder temperature self-correcting	●		●		●	
Heating dual protection and solid state relay control.	●		●		●	
USB interface, easy backup panel application update and mould parameters save	●		●		●	
Have stop memory function,random can store 240 sets mould data	●		●		●	
200 group abnormal alarm and 200 group modify record store	●		●		●	
Multi-level password settings to prevent the error revising/changing unintentionally and the user could be freely authorized the qualifier to access the related password level as request.	●		●		●	
Input, output point detection and i/o online simulation function, can quickly confirm the machine operation status.	●		●		●	
The front and rear door emergency stop switch protection	●		●		●	
Emergency stop switch protection of mold area (1200-4000eks)			●		●	
Quality data process monitoring interface.	●		●		●	
Production statistical process control real-time list interface (spc)	●		●		●	
Equipped with feeding and detective sensor(70-350EKS)	●					
Socket: 5-core 32A×1+5 core 16A×1, 3-core multi-function ×2	●	◎				
Socket: 5-core 32A×1+5 core 16A×1, 3-core multi-function ×2		◎	●			
Socket: 5-core 32A×2+5 core 16A×1, 3-core multi-function ×2		◎		◎	●	
Real-time energy consumption monitoring		◎		◎		◎
The(euro map)robot interface		◎		◎		◎
Hot runner interface		◎		◎		◎
Reserve air blow, core pulling, ejector backward protection and other kinds of interfaces.		◎		◎		◎
Techmation computer 12 inch color screen		◎		◎		◎
IV3100 computer (10 inch, 12 inch)		◎		◎		◎
Beckhoff computer (10 inch, 12 inch)multiple operating language		◎		◎		◎
Servo system adopts digital (CAN) communication (inovance drive)		◎		◎		◎
Built-in operating instructions for computer (IV3100 computer)		◎		◎		◎
Special requirement socket		◎		◎		◎
Computer network centralized control, network monitoring system.		◎		◎		◎
Injection moulding machine industry 4.0 networking function (RS232\CAN\ETHERCAT)		◎		◎		◎
Front and rear safety door light curtains protection		◎		◎		◎

● Standard ◎ Optional

Hydraulic Unit	70-470EKS		550-1850EKS		2200-4000EKS	
	Standard	Optional	Standard	Optional	Standard	Optional
Servo energing-savingsystem	●		●		●	
Oil temperature deviation automatic alarm	●		●		●	
Motor overload protection function	●		●		●	
Net oil suction filter	●					
Self-sealing soil filter			●		●	
Standard:one core pulling, reserve one core pulling(fixed platen)	●					
Standard with 2 core pulling(1 on fixed & 1 moving),reserve 2 core pulling(1 on fixed & 1 on moving) with core hold and release function.			●		●	
Uncovering high pressure hose with explosion-proof chain	●		●		●	
Mold open differential device	●		●		●	
Imported famous brand hydraulic control valve.	●		●		●	
Imported famous brand hydraulic seals.	●		●		●	
Imported nameplate high pressure hose.	●		●		●	
Multi-group sequential injection function (electrical interface)		◎		◎		◎
Multi-group sequential injection function (independent 11kw servo pump, ordinary motor, pneumatic valve available.)		◎		◎		◎
High precision bypass filter		◎		◎		◎
Enlarge plasticizing motor		◎		◎		◎
Ejector backward buffering function		◎		◎		◎
Nitrogen injection function (ACC)		◎		◎		◎
Special numbers of core pulling		◎		◎		◎
Enlarge pump motor power		◎		◎		◎
Injection servo valve		◎		◎		◎
Injection proportional valve		◎		◎		◎
Mold open/clos proportional valve.		◎		◎		◎
Ejector proportional valve		◎		◎		◎

Other	70-470EKS		550-1850EKS		2200-4000EKS	
	Standard	Optional	Standard	Optional	Standard	Optional
Standard machine color of Bole EKS	●		●		●	
Adjustable level pad	●		●		●	
Ground steel plate(1850-4000EKS)Ground bolt			●		●	
Spare parts tool box,common tools ,vulnerable parts ,extended nozzle,user's guide	●		●		●	
Pick-up platform(1850-4000eks)			●		●	
Machine fixed l-shaped positioning block		◎		◎		◎
Special color (for cover)		◎		◎		◎
Robot		◎		◎		◎
Magnetic shelf		◎		◎		◎
Hopper dryer		◎		◎		◎
Auto-loader		◎		◎		◎
Fumigation wood package		◎		◎		◎
Hydraulic oil		◎		◎		◎
Multiple language warning signs		◎		◎		◎